

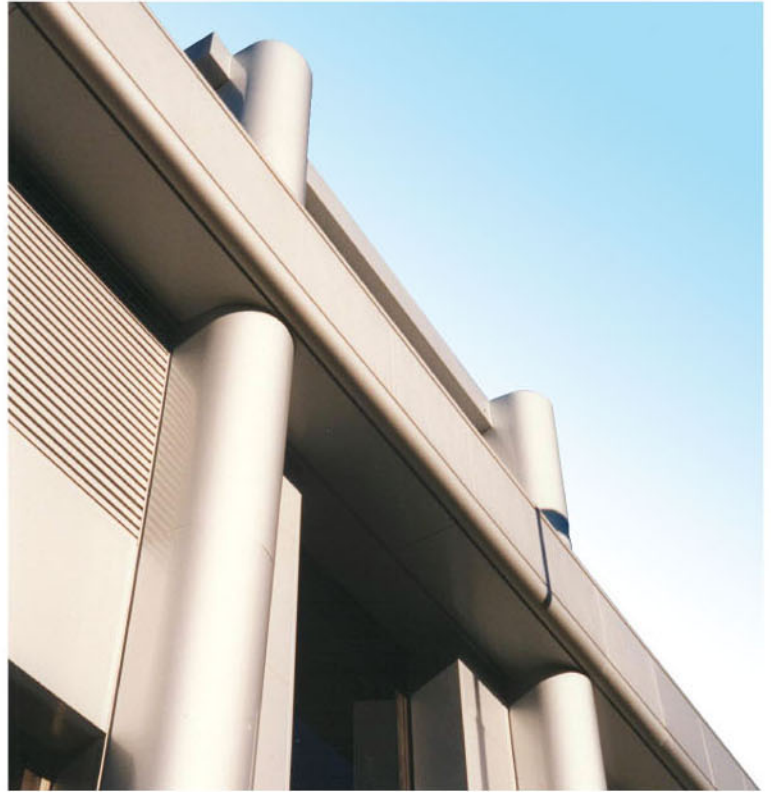

We can design and produce the aluminum claddings and wall panels according on your request.

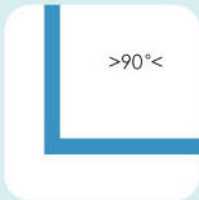

FREE BENDING FEATURES



Angle



Radian

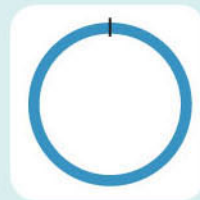

Round



By design

Structure Layer of aluminum single panel

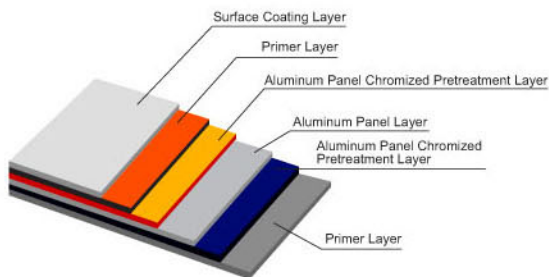

pre-painted coating

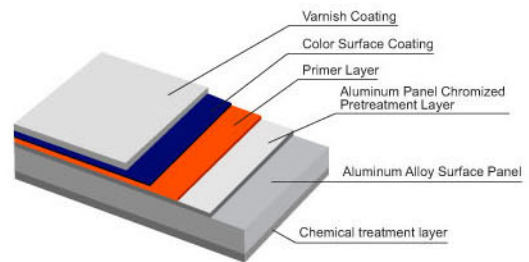

Fluorocarbon spray coating

JOINT DETAILS OF ALUMINUM SINGLE PANEL AND CURTAIN WALL

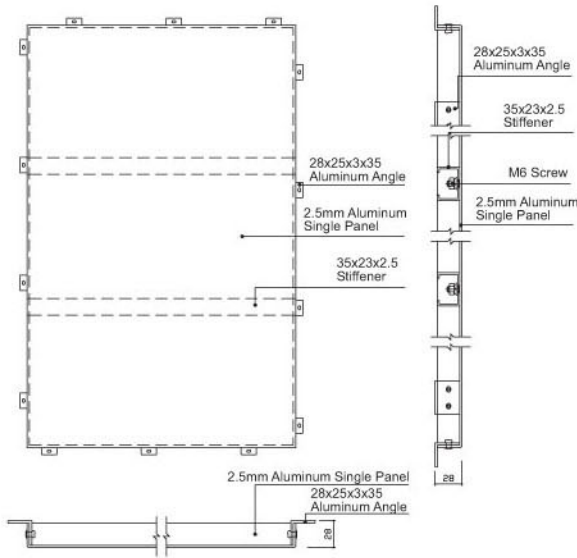

Plan Drawing Of Aluminum Single Panel

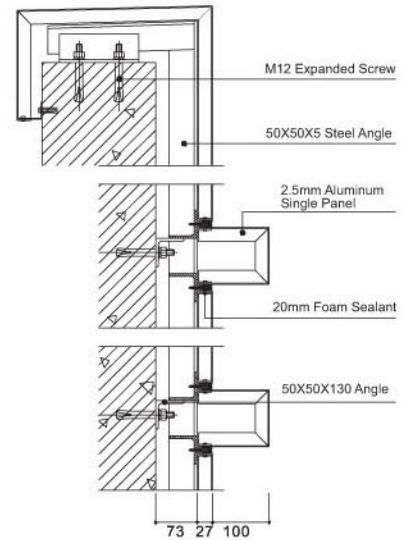

Side View Installation Drawing For Curtain Wall

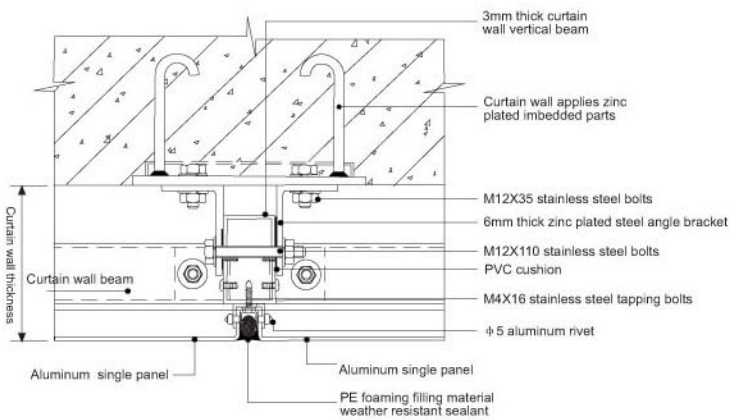

Joint details of aluminum single panel and curtain wall

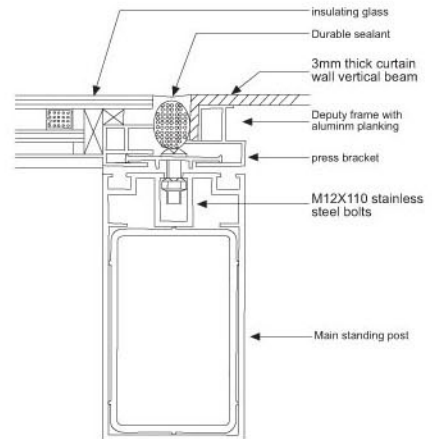

Joint details of aluminum single panel and glass curtain wall

PERFORMANCE

Aluminum Alloy Model	Tensile Strength(n/mm ²)	Yield Strength (n/mm ²)	Extensibility (%)	Bending Inside Radius (Thickness is 2mm)
A5052H44	230-280	180	More Than 5	R=2mmX2.5
A3003H44	210-265	180	More Than 4	R=2mmX2